

Round ceiling suspended luminaire made from artisanal handblown glass; surface White; aluminium heat sink and top plate; polycarbonate canopy; with COB (Chip on Board) technology for maximum efficiency; Phase-cut dim; light colour 2700 K; ≤ 3 SDCM (initial MacAdam); CRI ≥ 98 ; degree of protection IP20; Class 2; inclusive cable suspension max. 3000 mm; light source replaceable by Wastberg+ or by a professional with explicit authorization; control gear not replaceable;

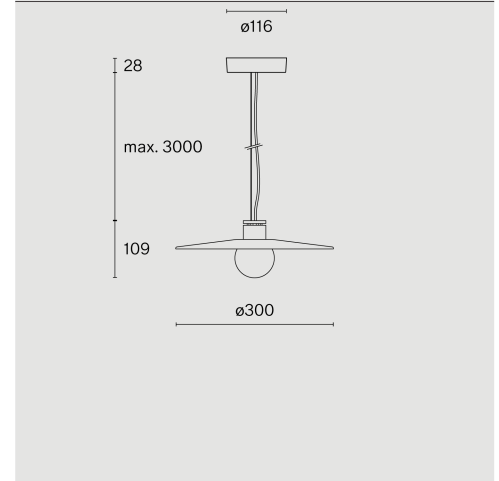
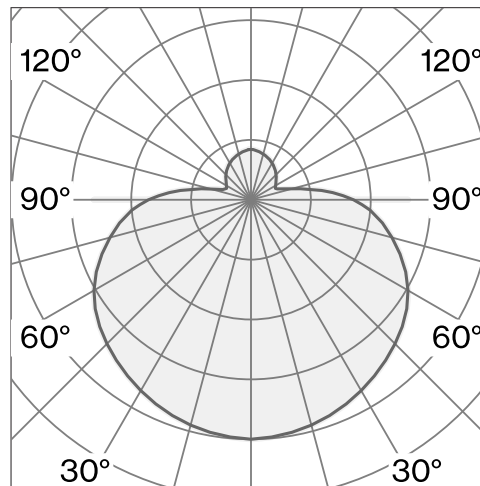

TECHNICAL INFORMATION

Physical	
Material	Shade & Bulb: Opal Glass
IP Rating	IP20
Safety Class	Class II

LED	
Colour Rendering Index	CRI ≥ 98
Lumen Maintenance	L80 / 50000h
Macadam Ellipse	≤ 3 SDCM (initial MacAdam)

More technical information online
wastberg.com/en/products/halo-suspended-w202s3



ARTICLE-SPECIFIC INFORMATION

Mounting
Luminous Flux
Colour Temperature
Optic
Control
Voltage
Power
Weight

Colour / Finish
White

HALO SUSPENDED W202S3

Ceiling
479 lm
2700 K
Opal
Phase-cut dim
220 - 240 V
7.3 W
1.2 kg

Art. No. / EAN code
202S300 / 7330492008707